

# TURNTABLE COUCH

**ZEITRAUM**

## Aufbauanleitung 12/2017

### NOTWENDIGES WERKZEUG:

Steckschlüssel/ Ratsche

Den Tisch auf einer weichen Unterlage zusammenbauen (z.B. Decke) um Beschädigungen zu vermeiden!

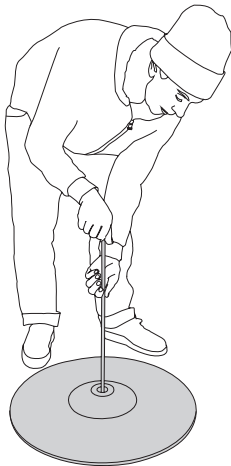

**1.** Die Tischplatte mit der Oberseite auf eine Decke o.ä. legen und die Gewindestange eindrehen.

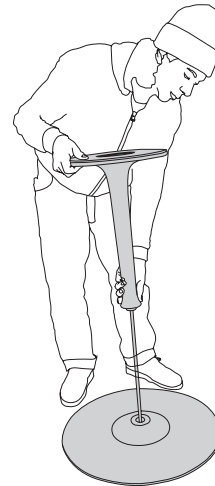

**2.** Fuß auf die Gewindestange setzen. Hierbei die Maserung des Fußes an der Maserung der Platte ausrichten.

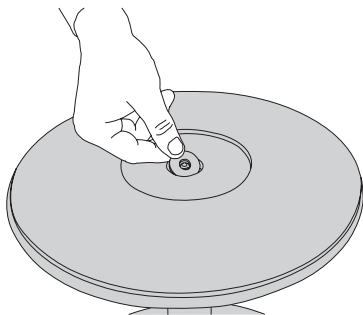

**3.** Beilagscheibe aufsetzen.

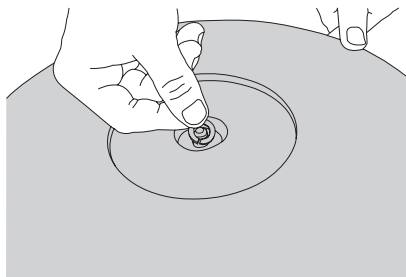

**4.** Sprengring aufsetzen.

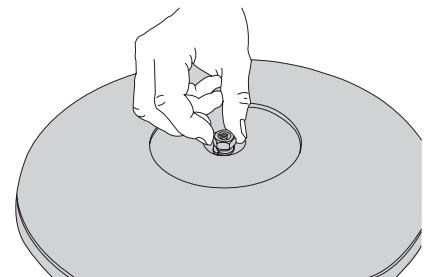

**5.** Zum Schluß Mutter eindrehen.

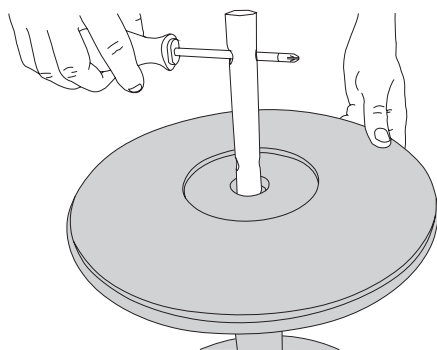

**6.** Mutter mit Steckschlüssel/ Ratsche anziehen.

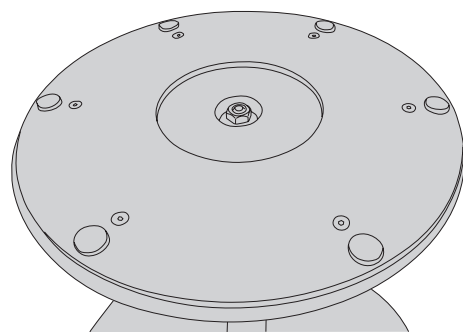

**7.** Die Filze gleichmäßig verteilt ankleben.

# TURNTABLE COUCH

**ZEITRAUM**

## assembly instruction 12/2017

### TOOLS REQUIRED:

socket wrench

Please fix up the table on a soft surface to avoid damages!

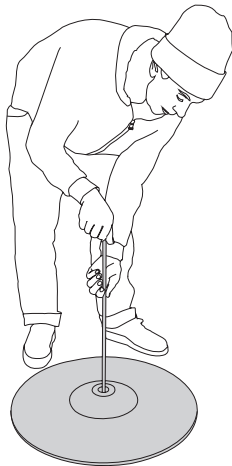

**1.** Place the tabletop upside down on a blanket and screw in the threaded rod.

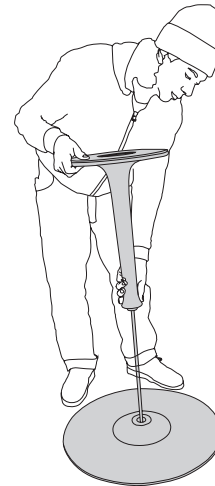

**2.** Place the tableleg on the threaded rod. Please ensure the wood grain of the base plate and the tabletop runs in the same direction.

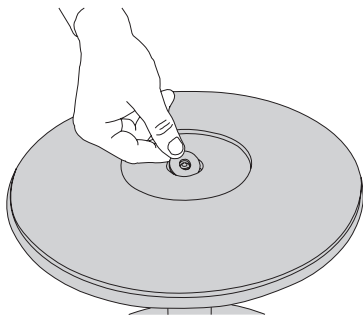

**3.** Place the washer...

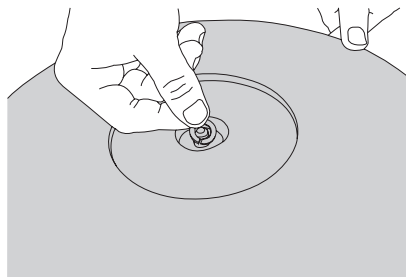

**4.** ... then the lockwasher...

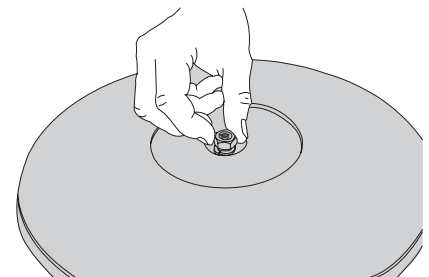

**5.** ... at last screw in the screw nut.

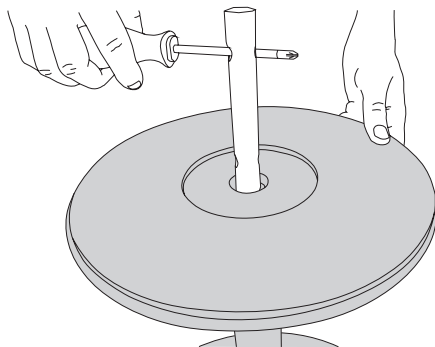

**6.** Tighten the screw nut with the socket wrench.

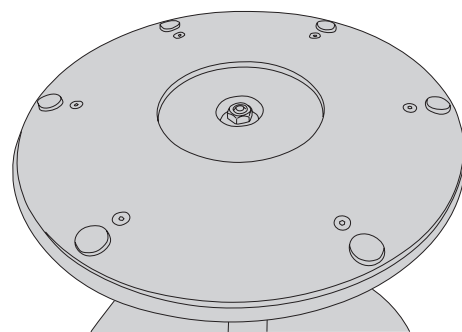

**7.** Place the felt pads evenly distributed.