

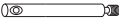









## assembly instruction 02/2021

### Tools:

Allen screw SW4 and SW5 (enclosed), crosstip screwdriver

4 x XS steel bolts		12 x grub screws	
8 x XS steel bolts		3 x countersunk bolts (M8x50)	
12 x connector housings		3 x adjustable centre feet	
24 x confirmat screws		4 x mounting blocks	
8 x confirmat screws (M6x50)		4 x button head screws (M6x40)	

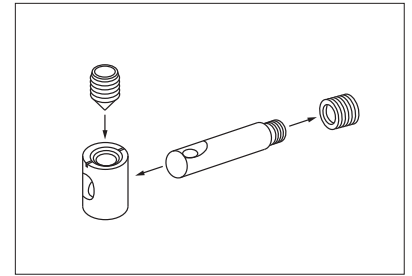

Watch this video for further information on the metal fitting:  
<https://www.youtube.com/watch?v=ioUTDqtvGE>

Please do the setup of the bed on a soft surface (e.g. a carpet or blanket) to avoid damages.

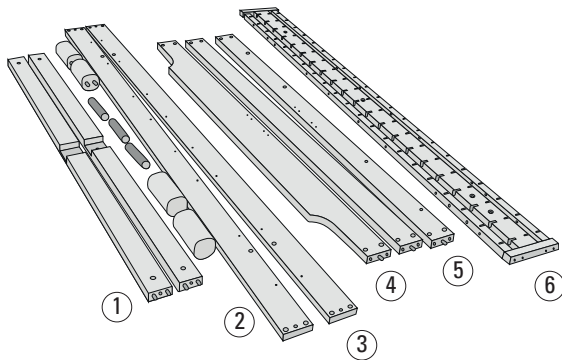

- 1 Crossbars
- 2 Bed and centre feet
- 3 Side rails
- 4 Footboard and headboard
- 5 Headboard with upholstery hole
- 6 Centre rail and support bars

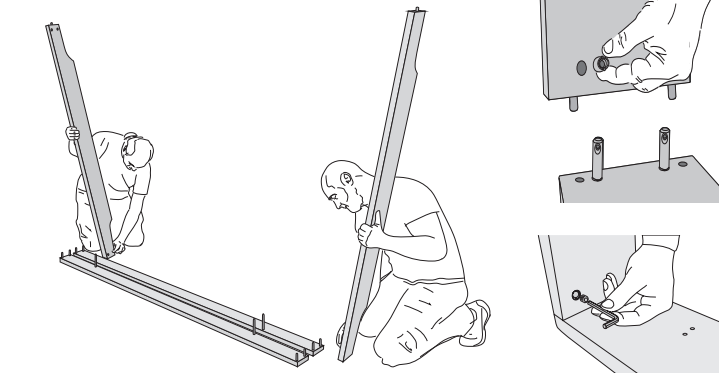

1. Screw all XS bolts into side rails (3) and insert the connector housings into the foot and head sections (4) and crossbars (1). Align bolts and housings correctly! Mount foot and headboard (4) as well as the headboard with upholstery hole (5) to the side rails and fix with grub screws.

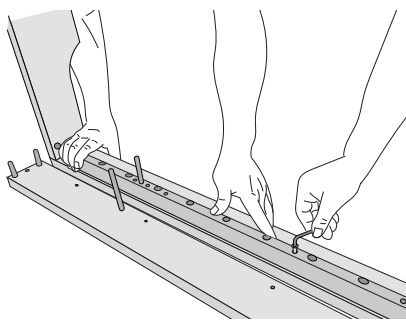

2. Mount the support bars (6) on the side rails (3) using confirmat screws.

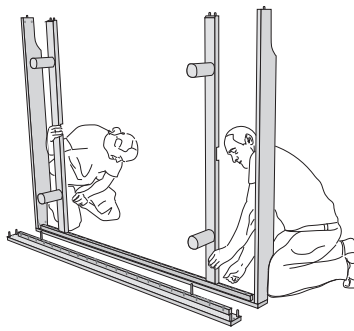

3. Now place the two bed feet (2) on the crossbars (1) and mount them on the long side (3). Then attach the second long side and fix it in place.

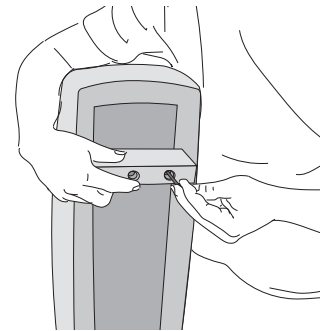

4. Attach the mounting blocks to the bottom of the cushion.

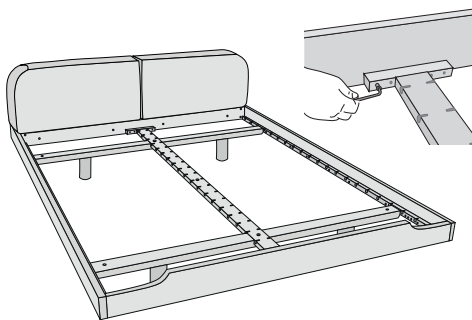

5. Place the bed on its feet. Insert the cushions between the head rails. Then insert the centre rail (6) and screw it in place.

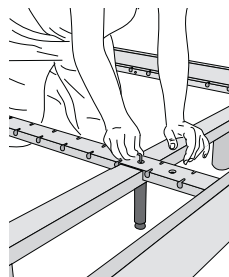

6. Mount the adjustable center feet (2) to the centre bar (6) using countersunk screws. Mind the correct length and fix the cushion.

