

Aufbauanleitung 03/2021**WERKZEUG:**

Innensechskantschlüssel SW5 (beiliegend)

8 x XS Bolzen



8 x Verbinder Gehäuse

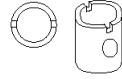

8 x Madenschrauben



Zylinderkopfschrauben

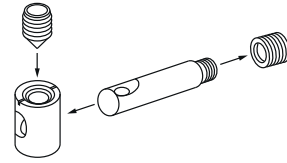

Bitte beachten Sie die Funktionsweise der Beschläge:
<https://www.youtube.com/watch?v=ioIUTDqtvvE>

- 1.** XS Bolzen locker in die Beinpaare schrauben und die Längszargen mit den Gehäusen bestücken.
 Darauf achten, dass der Längsschlitz des Gehäuses in Richtung zum XS Bolzen ausgerichtet ist.

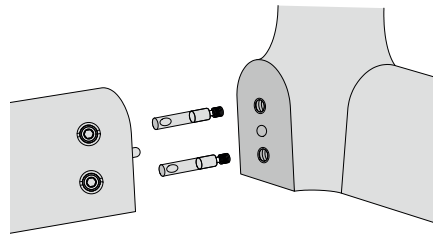

- 2.** Gestell zusammensetzen, indem die Längszargen auf die Bolzen gesteckt werden. Die
 Verbinder mit den Madenschrauben fixieren, **Zargen und Beinpaare sind nummeriert:**

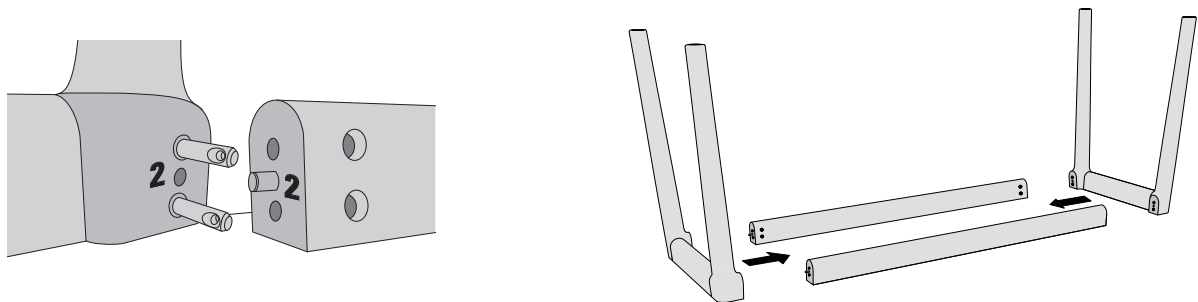

- 3.** Gestell mit den Maschinenschrauben auf die Tischplatte schrauben:

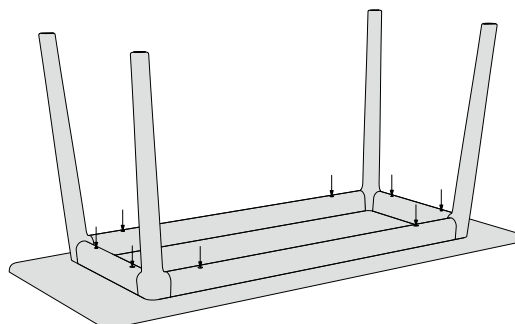

assembly instruction 03/2021**TOOLS REQUIRED:**

Allen screw SW 5 (enclosed)

8 x XS bolts



8 x boxes

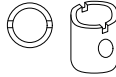

8 x grub screws



cylinder head screws

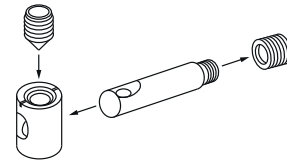

Watch this video for further information on the metal fitting:
<https://www.youtube.com/watch?v=ioUTDqtvgE>

1. Screw the XS bolts into the pairs of legs (do not overtighten!) and insert the boxes into the side rails. Align the slots of the boxes with the XS bolts.

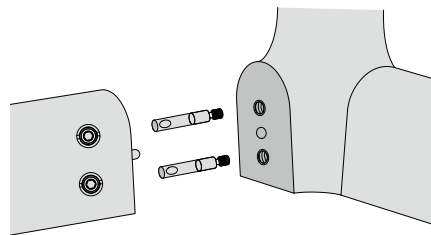

2. Assemble pairs of legs and side rails **according to the numbers**. Connect the parts and tighten the connectors with grub screws.

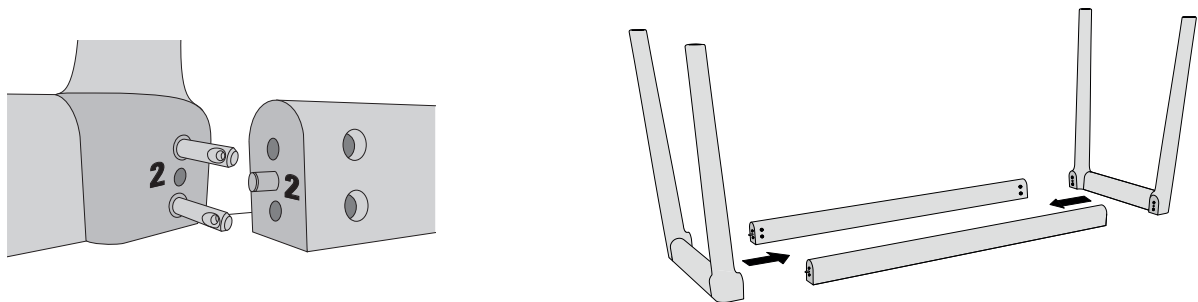

3. Screw the frame onto the table top:

