







# ECLAIR PETIT

**ZEITRAUM**

## assembly instruction 02/2021

### Tools:

Allen screw SW4 and SW5 (enclosed), crosstip screwdriver

4 x XS steel bolts		12 x grub screws	
8 x XS steel bolts		3 x countersunk bolts (M8x50)	
12 x connector housings		3 x adjustable centre feet	
24 x confirmat screws			

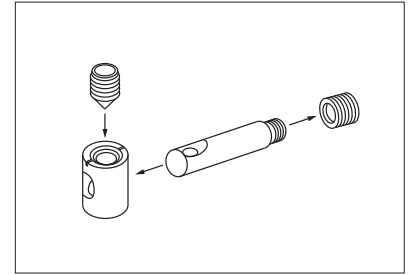

Watch this video for further information on the metal fitting:  
<https://www.youtube.com/watch?v=ioiUTDqtvGE>

Please do the setup of the bed **on a soft surface (e.g. a carpet or blanket)** to avoid damages.

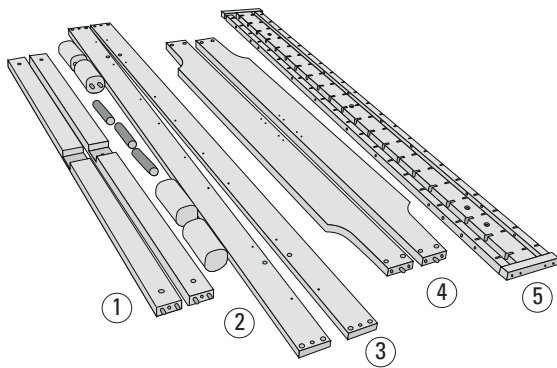

- 1 Crossbars
- 2 Bed feet and centre feet
- 3 Side rails
- 4 Footboard and headboard
- 5 Centre rail and support bars

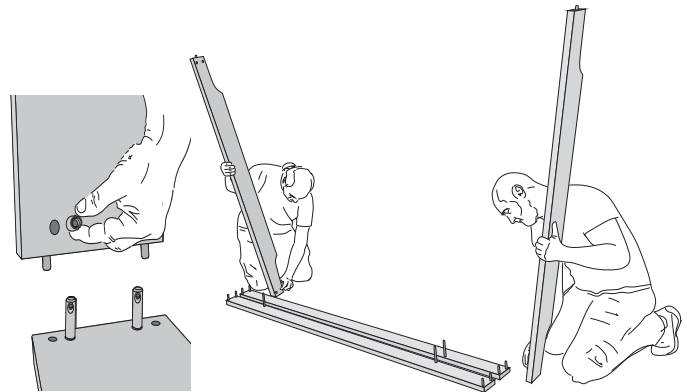

1. Screw all XS bolts into side rails (3) and insert connector housings into the foot and head sections (4) and crossbars (1). Align the bolts and housings correctly! Mount foot and headboards to the side rails and fix them with grub screws.

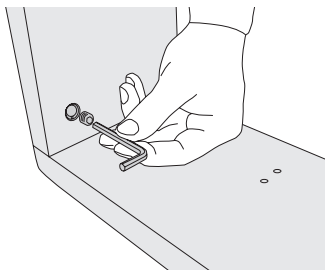

2. Use the grub screw to tighten the connections of side rail, foot and headboard.

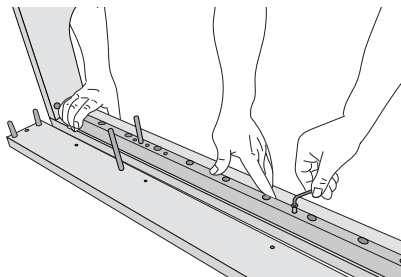

3. Mount the support bars (5) on the side rails (3) using confirmat screws.

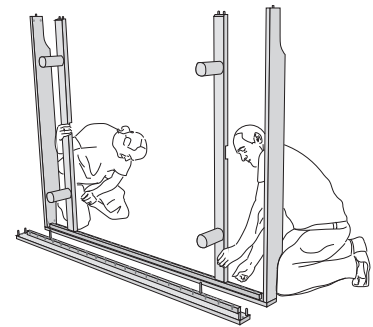

4. Now place the two bed feet (2) on the crossbars (1) and mount those to the side rail (3). Then attach the second side rail and fix it in place.

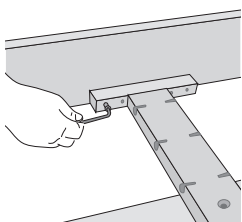

5. Place bed on its feet. Then insert the centre rail (5) and screw it in place.

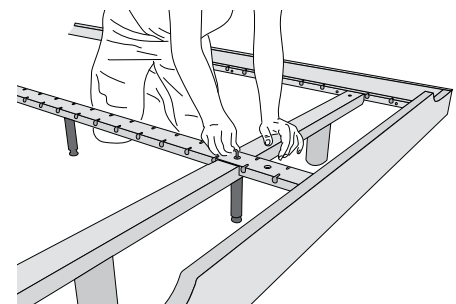
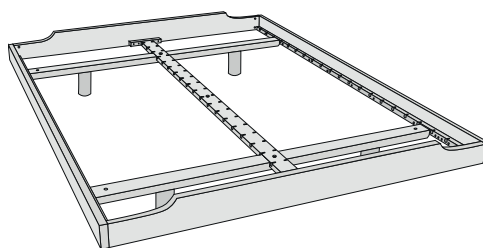

6. Mount the adjustable centre feet (2) to the centre rail (5) using countersunk screws. Mind the correct length.