

# TURNTABLE COUCH

**ZEITRAUM**

## assembly instruction 12/2017

### TOOLS REQUIRED:

socket wrench

Please fix up the table on a soft surface to avoid damages!

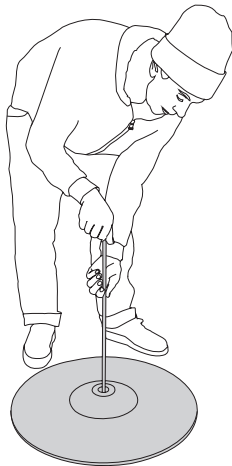

**1.** Place the tabletop upside down on a blanket and screw in the threaded rod.

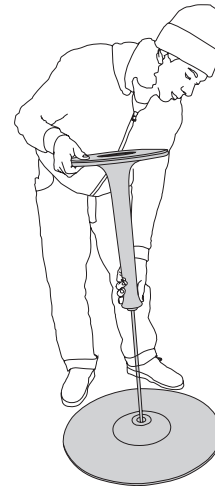

**2.** Place the tableleg on the threaded rod. Please ensure the wood grain of the base plate and the tabletop runs in the same direction.

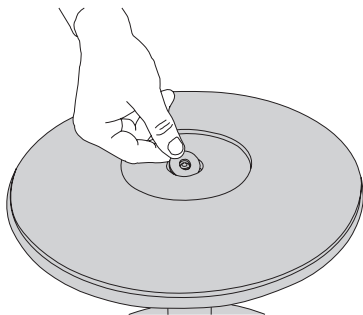

**3.** Place the washer...

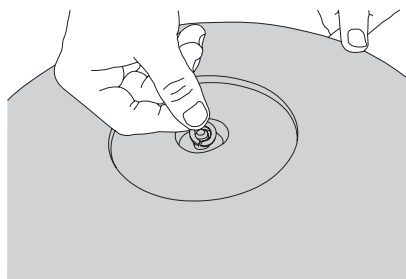

**4.** ... then the lockwasher...

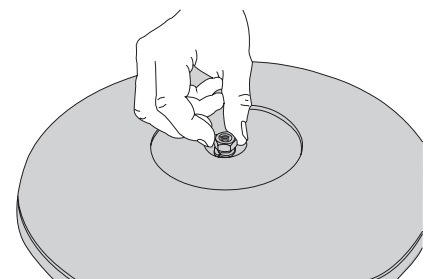

**5.** ... at last screw in the screw nut.

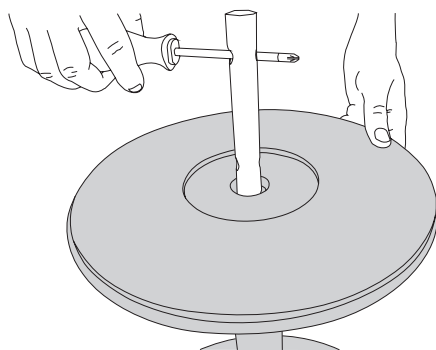

**6.** Tighten the screw nut with the socket wrench.

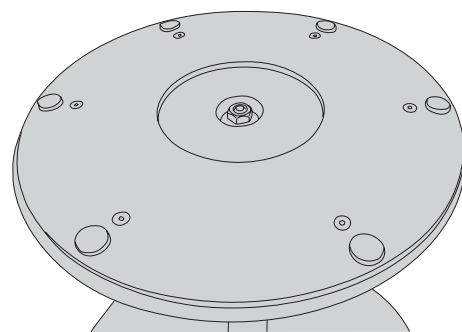

**7.** Place the felt pads evenly distributed.