







ECLAIR PETIT Bold

ZEITRAUM

Assembly instructions 01/2022

TOOLS:

allen key SW4 and SW5 (enclosed), crosstip screwdriver

10 x XS steel dowels		3 x Spax screws (5x100)	
10 x connector housings		3 x Spax screws (6x140)	
10 x grub screws		3 x distance blocks (100x60x50)	
24 x Confirmat screws		1 x center support foot, adjustable	
1 x countersunk screw (M8x60)			

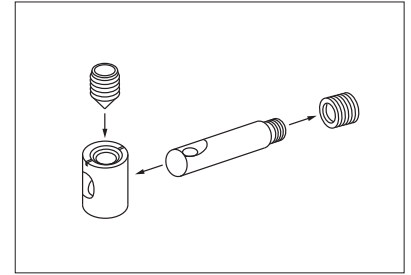

Watch this video for further information on the metal fitting:
<https://www.youtube.com/watch?v=ioIUTDqtvvE>

Please assemble the bed **on a soft surface (e.g. a carpet or blanket)** to avoid damages.

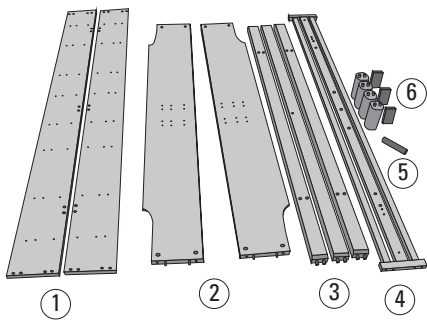

- 1 side rails
- 2 foot and headboard
- 3 crossbars
- 4 center rail and support bars
- 5 bed and center support feet
- 6 distance blocks

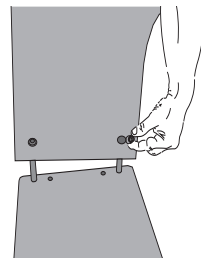

- 1. Screw XS dowels into side rails (1) and insert the connector housings into the holes. Align dowels and housings correctly! Mount foot and headboard (2) to the side rails.

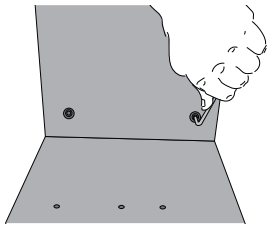
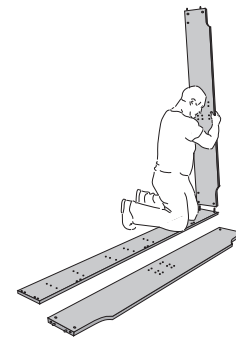

- 2. Fix the connection with grub screws.



- 3. Place the bed feet (5) on the crossbars (3) and attach them to the side rails. Fix the center crossbar with XS connectors. Then attach the second side rail.

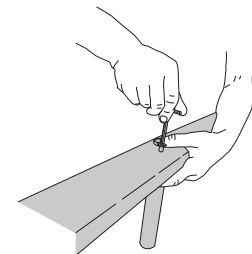

- 4. Mount the adjustable centre support foot to the center rail (6) using countersunk screw (M8).

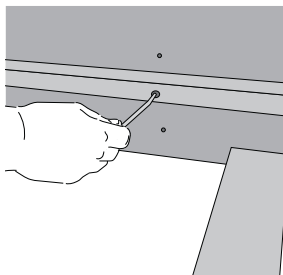

- 5. Fix the support bars to the side rails using Confirmat screws.

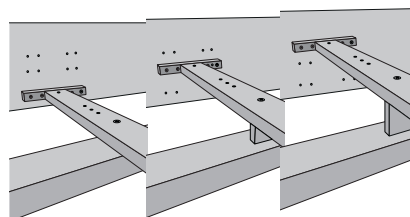

- 6. Mount the center rail at the same height as the support bars. Choose the right position of the distance blocks (6) and fix them with Spax screws in the right length (5x100, 6x140).

without distance block: insertion depth 16,5 cm
 horizontal distance block: insertion depth 10,5 cm
 standing distance block: insertion depth 6,5 cm