







## Assembly instructions 01/2022

### TOOLS:

Allen key SW4 and SW5 (enclosed)

- 12 x XS steel dowels 
- 12 x connector housings 
- 12 x grub screws 
- 24 x Confirmat screws (5x50) 
- 2 x countersunk screws (M8x50) 
- 2 x center support feet, adjustable 

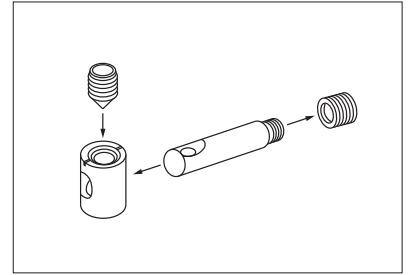

Watch this video for further information on the metal fitting:  
<https://www.youtube.com/watch?v=ioiUTDqtvvE>

Please assemble the bed on a soft surface (e.g. a carpet or blanket) to avoid damages.

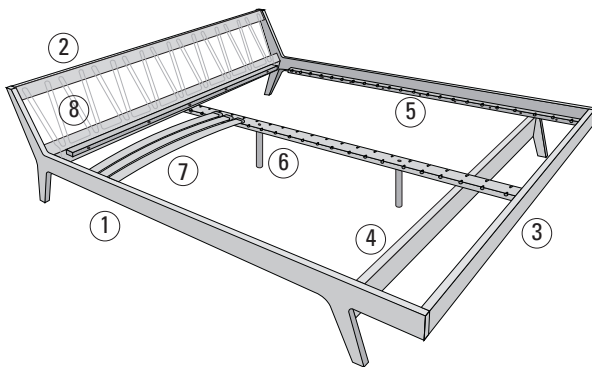

- 1** side rails
- 2** headboard
- 3** footboard
- 4** cross bar
- 5** support bars
- 6** center rail and center support feet
- 7** sprung slats and rubber caps
- 8** leather cord

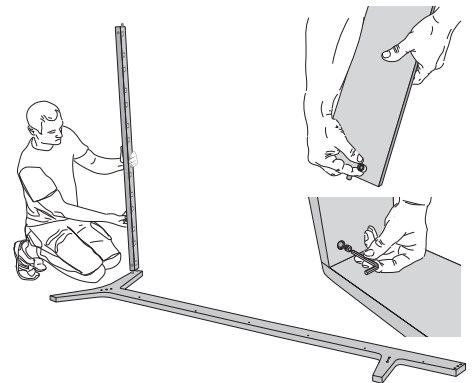

1. Screw steel dowels into the side rails (1). Insert connector housings into headboard (2), footboard (3) and cross bar (4). Ensure that dowels and housings are aligned correctly. Place the bars of the headboard (2) on one of the side rails (1) and fix the connectors using the allen key.

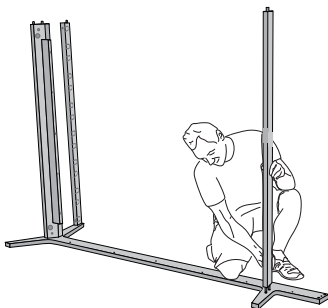

2. Attach the cross bar (4) to the side rail (1).

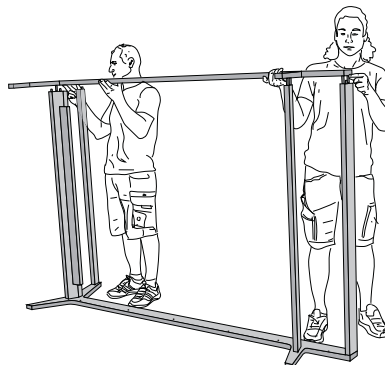

3. Attach the footboard (3) to the side rail (1). Place the second side rail on top of the parts that are already assembled.



4. Thread the leather cord (8) through the slots in the headboard (2). Before fixing it, tighten the cord slightly.

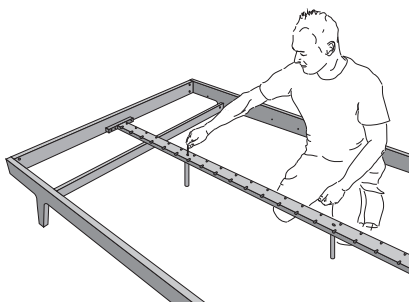

5. Attach the center rail (6) and fasten the center support feet to the center rail.

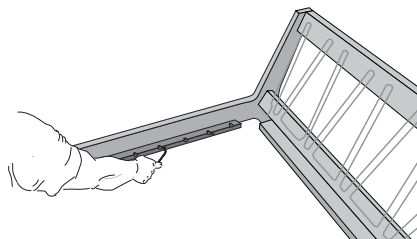

6. Attach the support bars (5) to the side rails (1) using confirmat crews.

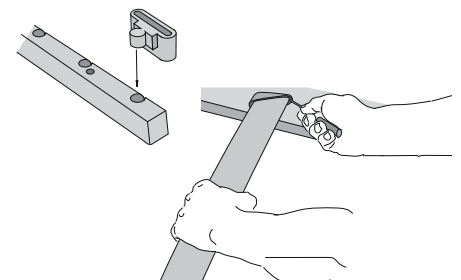

7. Insert the rubber caps (7) into the holes in the mattress supports and fit the sprung slats into the rubber caps.